

2

1

B

B

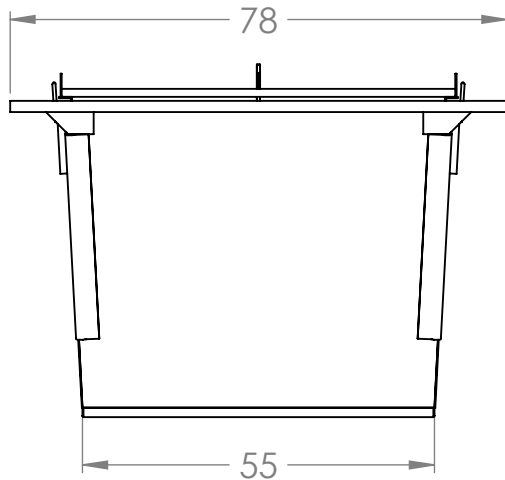
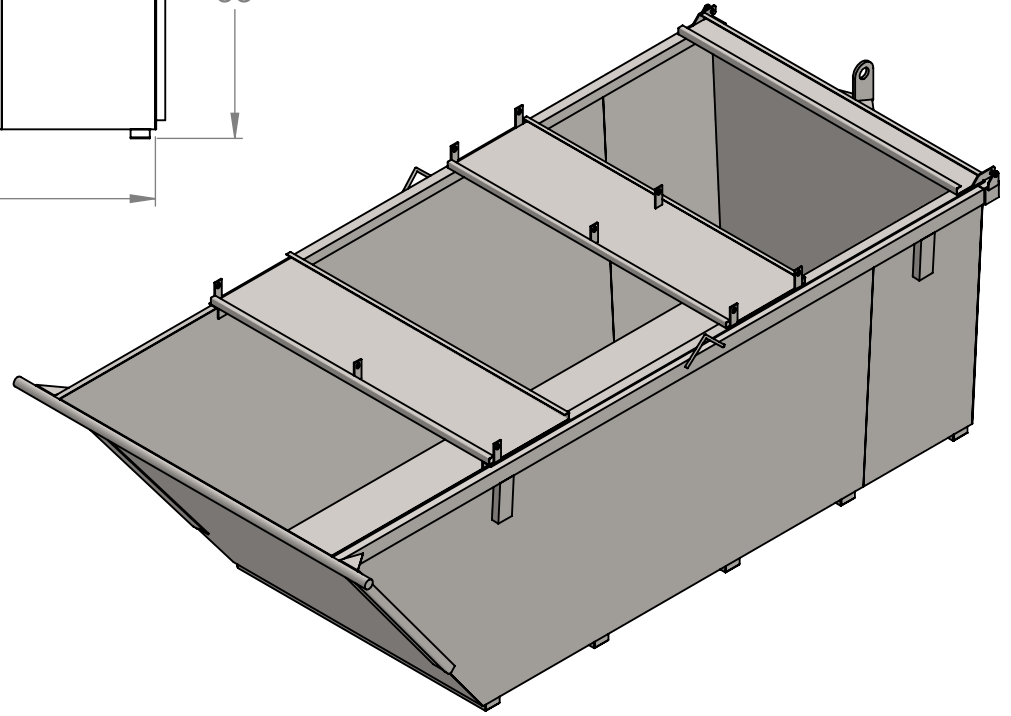
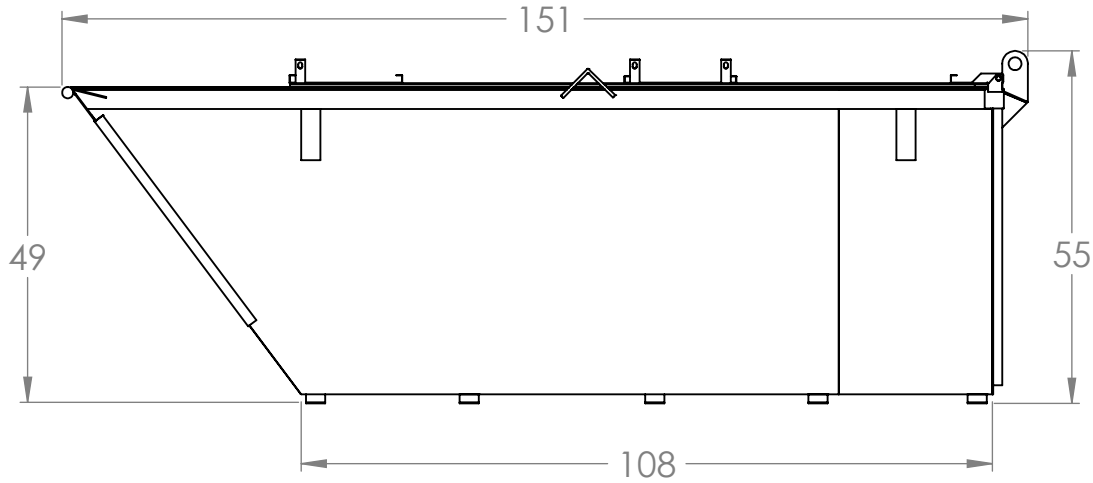

A

A

2

1

POYNETTE IRONWORKS

PROPRIETARY AND CONFIDENTIAL

THE INFORMATION CONTAINED IN THIS DRAWING IS THE SOLE PROPERTY OF POYNETTE IRONWORKS. ANY REPRODUCTION IN PART OR AS A WHOLE WITHOUT THE WRITTEN PERMISSION OF POYNETTE IRONWORKS IS PROHIBITED.

UNLESS OTHERWISE SPECIFIED:		TITLE:	
DIMENSIONS ARE IN INCHES		PART NO:	
TOLERANCES:		8 RLST	
FRACTIONAL	±1/2	SIZE	DESIGNED BY:
WEIGHT	±5%	A	DATE:
MATERIAL			3/26/2020
		SCALE:	1:30 WEIGHT: 1250
			REV -
			SHEET 1 OF 1